ATLANTA

STRETCH



NOVA

AUTOMATIC WRAPPING MACHINE
EASY INSTALLATION

Rotary ring for wrapping pallets with stretch film

NOVA
45 RPM

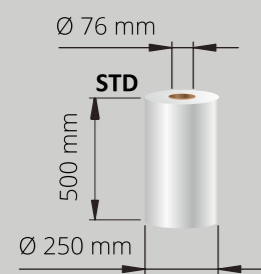

PALLET DIMENSIONS

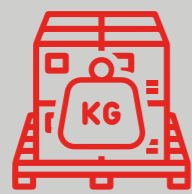

AT REQUEST

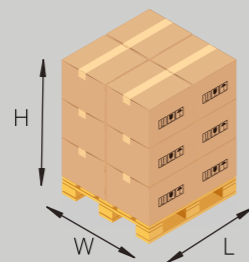

	Ø	WxL mm	
Max	1700	1200X1200	STD

APPLICATIONS

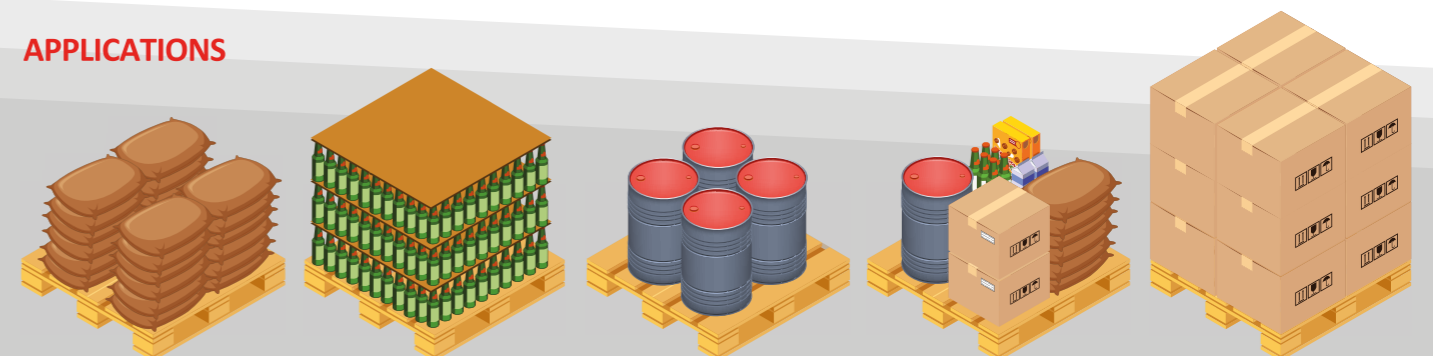



SELLING POINTS & MAIN OPTIONALS



SAFETY SYSTEM

- IT** Sistema automatico di anticaduta anello ad arresto istantaneo.
- EN** Automatic ring fall arrest system with instantaneous stop.
- FR** Système automatique d'arrêt de chute anneau avec arrêt instantané.
- DE** Automatisches Fallsicherung für den Ring mit sofortigem Stopp.
- ES** Anticaídas automático de anillo con parada instantánea.



SELF ADJUSTING WELDING UNIT

- IT** Sistema pinza taglio saldatura del film estensibile autoregolante per qualsiasi dimensione del pallet.
- EN** Film cutting, clamping and welding unit which is self-adjusting for any size of pallet.
- FR** Système de pince, coupe et soudure du film étirable à réglage automatique pour toutes dimensions de la palette.
- DE** Selbsteinstellendes Folienende Verschweißsystem passt sich auf sämtliche Palettengrößen automatisch an.
- ES** Sistema corte pinza soldadura del film extensible autorregulable para cualquier dimensión de palet.



CONTRAST PLATE

- IT** Saldatura su contrasto per garantire una perfetta saldatura della coda finale del film.
- EN** Welding is completed against a contrast plate, this guarantees a perfect film joint at the end of the final wrapping cycle.
- FR** Soudure sur contre-mors pour garantir une fixation parfaite du film en fin de cycle de banderolage.
- DE** Folienendever schweißung gegen Kontrastplatte für eine perfekte Fixierung am Ende des Wickelzyklus.
- ES** Dispositivo de soldadura con placa de contraste, para garantizar el perfecto sellado de la cola del film.



SELLING POINTS & MAIN OPTIONALS

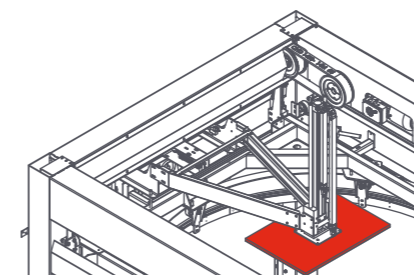

TOP PLATE UNIT

- IT** Pressore tenuta pallet.
- EN** Pallet top pressure unit.
- FR** Plateau stabilisateur de charge.
- DE** Palettenniederhalter.
- ES** Prensor retención palet.

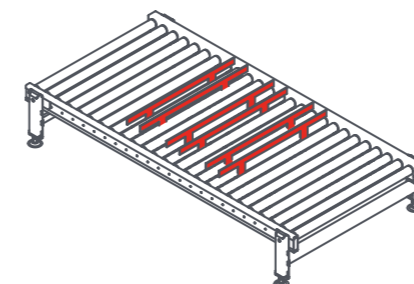

PALLET LIFTER

- IT** Sollevatore Pallet.
- EN** Pallet Lifter.
- FR** Releveur de charges.
- DE** Paletten Hubvorrichtung.
- ES** Elevador palet.

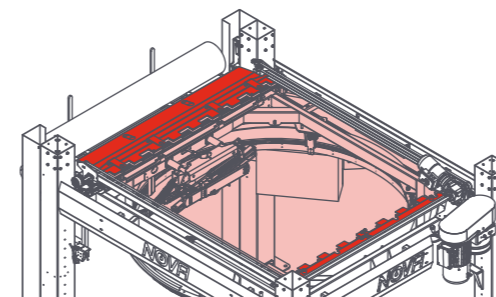

TOP COVER SYSTEM

- IT** Dispositivo di copertura ermetica o antipolvere del pallet.
- EN** Waterproof or Dustproof pallet cover device.
- FR** Dispositif de dépose de coiffe hermétique ou anti-poussière.
- DE** Deckblattaufleger für Staub-oder Wassergeschützte Palettenverpackung.
- ES** Dispositivo de cobertura hermetica o antipolvo del palet.



ROPING SYSTEM

- IT** Sistema a corda: Permette di ridurre l'altezza del film formando un cordone che assicura una più efficiente stabilizzazione del carico.
- EN** Roping System: Reducing the film width, to form a rope ensuring a more effective load stabilisation.
- FR** Systeme permettant de réduire la laize du film en formant un cordon qui assure une meilleure stabilisation de la charge.
- DE** Schnurrvorrichtung: Reduzierung der Folienbreite zur Schnur um eine bessere Stabilisierung der Ladung zu gewährleisten.
- ES** Sistema de Cordón. Permite reducir la altura del film formando un cordón que asegura con mas eficacia la estabilidad de la carga.

EASY INSTALLATION

L'installazione non richiede l'utilizzo di un carro ponte o di una gru.
Installation does not require the use of a crane or overhead crane.

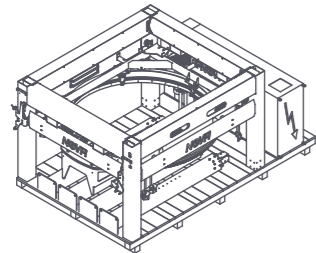

FASE 1

- IT** Nova può essere spedita in container 40 HC su bancale in legno.
- EN** Nova can be shipped in a 40 HC container on a wooden pallet.

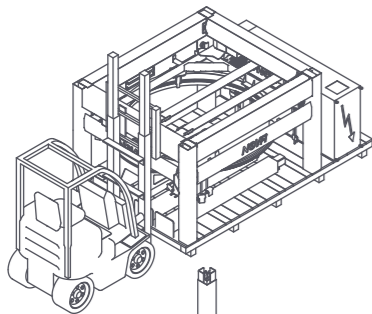

FASE 2

- IT** Utilizzando un muletto 3t si solleva la parte superiore del macchinario.
- EN** Using a 3t forklift you lift the top of the machine.

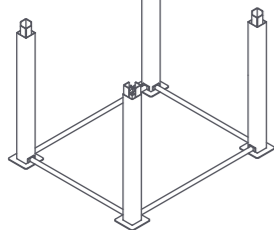

FASE 3

- IT** Montare le gambe inferiori nella posizione corretta mediante l'utilizzo dei traversi.
- EN** Install the lower legs in the correct position using the crossbars.

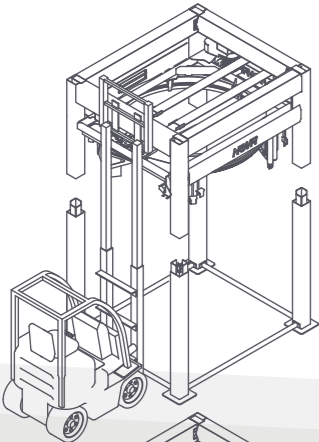

FASE 4

- IT** Innestare la parte superiore del macchinario nelle gambe inferiori.
- EN** Engage the upper part of the machine in the lower legs.

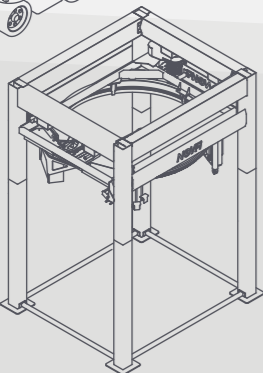

FASE 5

- IT** Fare riferimento al manuale d'uso per l'utilizzo.
- EN** Refer to the user manual for instructions for use.

SPOOL FILM CARRIAGE

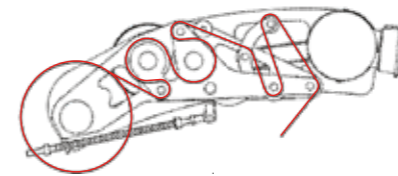

INFINITY STRETCH

- IT** L'evoluzione finale dei carrelli di prestiro con un abbraccio di film senza eguali per minimizzare gli slittamenti e avere il miglior prestiro di sempre
- EN** The ultimate evolution of pre-stretch carts with an unrivalled film hug to minimise slippage and have the best pre-stretch ever.
- FR** L'évolution ultime des chariots de pré-étirage avec une étreinte de film inégalée pour minimiser le glissement et obtenir le meilleur pré-étirage jamais réalisé.
- DE** Die ultimative Evolution der Vorstreckwagen mit einer konkurrenzlosen Folienanschmiegung, um das Verrutschen zu minimieren und die beste Vorstreckung aller Zeiten zu erzielen.
- ES** La evolución definitiva de los carros de preestirado con un abrazo de película inigualable para minimizar el deslizamiento y tener el mejor preestirado de la historia.

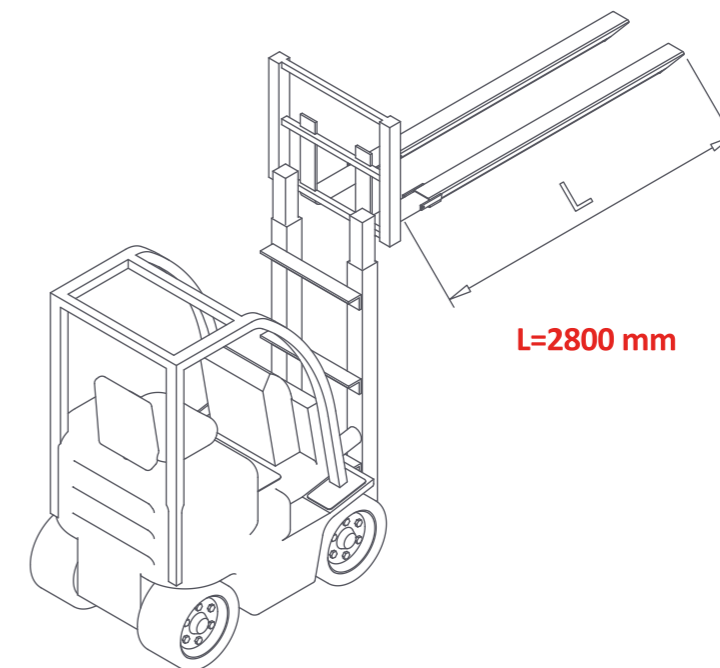

WRAPPING PROGRAMS

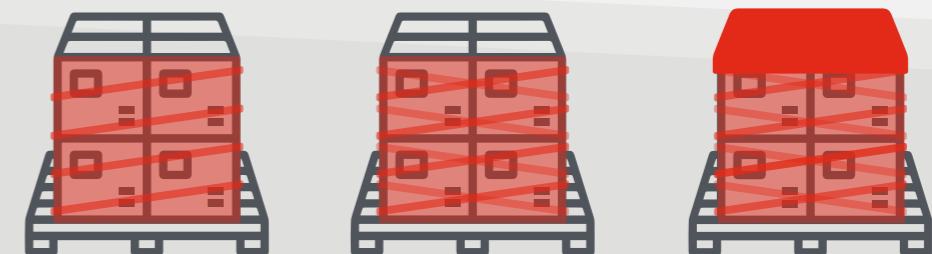

AUTOMATIC RANGE

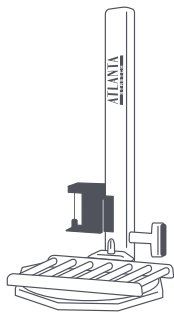

MYTHO STATION

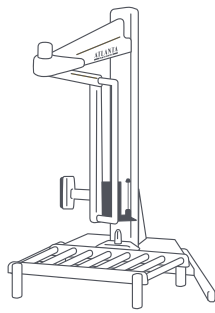

LYBRA STATION

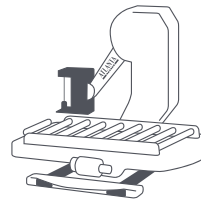

MYTHO A ARM

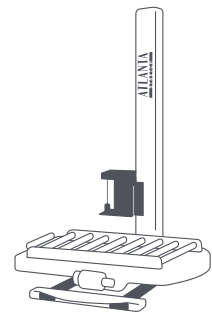

MYTHO A MAST

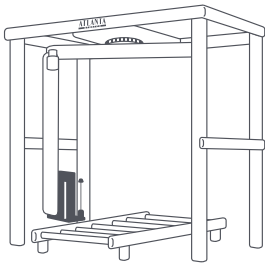

REVOLUTION LS

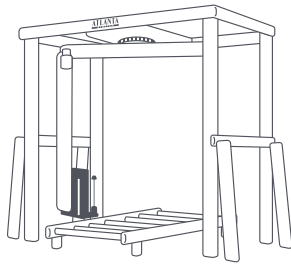

REVOLUTION HS

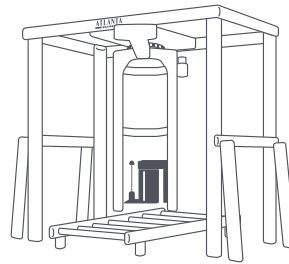

REVOLUTION HD

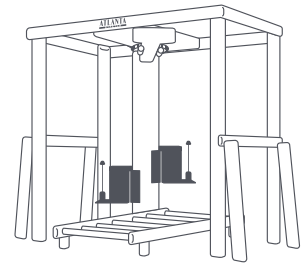

REVOLUTION DOUBLE

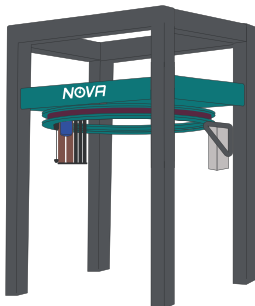

NOVA

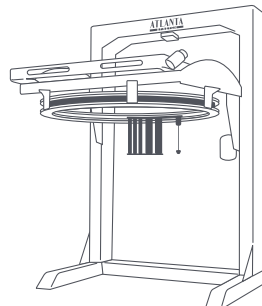

OMEGA

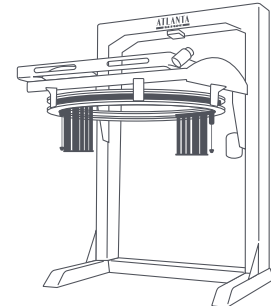

OMEGA DOUBLE

Atlanta Stretch Authorized dealer



Headquarter: Atlanta Stretch Italy Spa

Subsidiaries: Atlanta Stretch Australia - Atlanta Stretch China - Atlanta Stretch Deutschland - Atlanta Stretch France - Atlanta Stretch Iberica - Atlanta Stretch India - Atlanta Stretch Mexico - Atlanta Stretch Russia - Atlanta Stretch SEA - Atlanta Stretch Sweden - Atlanta Stretch Turkey - Atlanta Stretch UK

www.atlantastretch.com

Find all our dealers

